

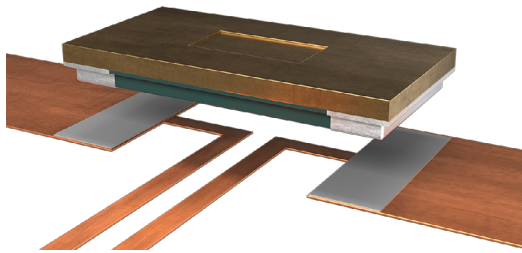

## ISA-PLAN® // PRECISION RESISTORS

### FMK // Size 1206



#### Features

- Power rating up to 3.5 W at 70 °C (2 mOhm)
- Constant current up to 41 A (2 mOhm)
- Small size (1206)
- High pulse power rating
- Excellent long-term stability
- Mounting: Reflow- and IR-soldering / vacuum soldering recommended
- AEC-Q200 qualification
- RoHS 2011/65/EU compliant



#### Applications

- Current sensor for power hybrid applications
- Control systems for the automotive market
- Power modules
- Frequency converters
- Switch mode power supplies

#### Technical data

Resistance values	<b>mOhm</b>	2 / 3 / 4 / 5 / 6
Tolerance	<b>%</b>	1 / 5 / 10
Temperature coefficient (20-60 °C)	<b>ppm/K</b>	<50
Applicable temperature range	<b>°C</b>	-65 to +170
Power rating	<b>W</b>	up to 3.5
Dielectric withstanding voltage	<b>V AC/DC</b>	200
Inductance	<b>nH</b>	<1
Stability (at rated power) deviation after 2000h, T <sub>k</sub> = Terminal temperature		< 0.5 % (TK=80 °C) < 1.0 % (TK=110 °C)

Type	Value [mΩ]	Rthi [K/W]	TCR (20-60 °C) [ppm/K]	P <sub>70°C</sub> [W]	P <sub>110°C</sub> [W]	Available tolerances		
						1 %	5 %	10 %
FMK-M-R002	2	<26	<50	3.5	2	✓	✓	
FMK-M-R003	3	<34	<50	3	1.5	✓	✓	
FMK-V-R004	4	<42	<50	2	1.5	✓	✓	✓
FMK-V-R005	5	<50	<50	2	1	✓	✓	
FMK-V-R006	6	<58	<50	1.5	1	✓	✓	

Abbreviation type M=MANGANIN®, V=NOVENTIN®

#### Ordering code

FMK - M - R002 - 1.0

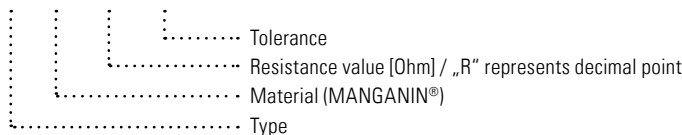



**FMK // Size 1206**

**Recommended solder profile**

Reflow- and vacuum soldering

Temperature	°C	260	255	217
Time	sec	peak	40	90

**Tape and reel information**

Specification	DIN EN 60286-3			
Tape width	mm	8		
Reel size	inch	13		
Parts per reel	pcs	12500		
Packaging weight net	g	454		

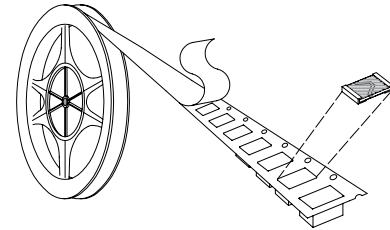

**Information**

Parts are currently not marked

**Mechanical dimensions and pcb-layout proposal (Reflow-soldering) [mm] / Drawing Z-YL-258b**

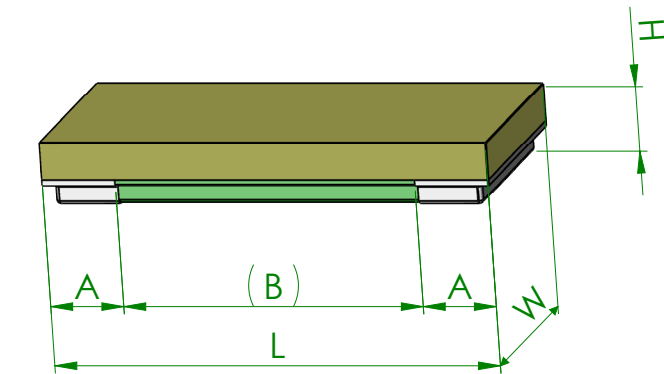

L	W	H	A	B
3.05 ±0.2	1.52 ±0.2	0.4 ±0.2	0.5 ±0.2	(2.05)

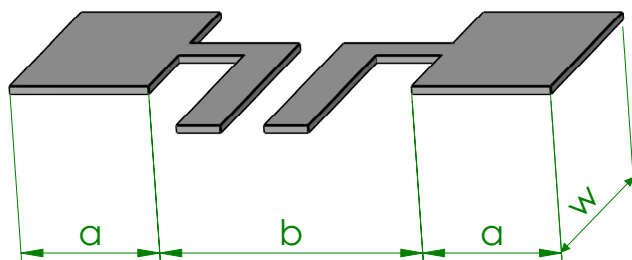

a	b	w
1.00	1.80	1.65

Recommended copper layer thickness 105µm



**FMK // Size 1206**

**Temperature dependence of the electrical resistance of MANGANIN® resistors**

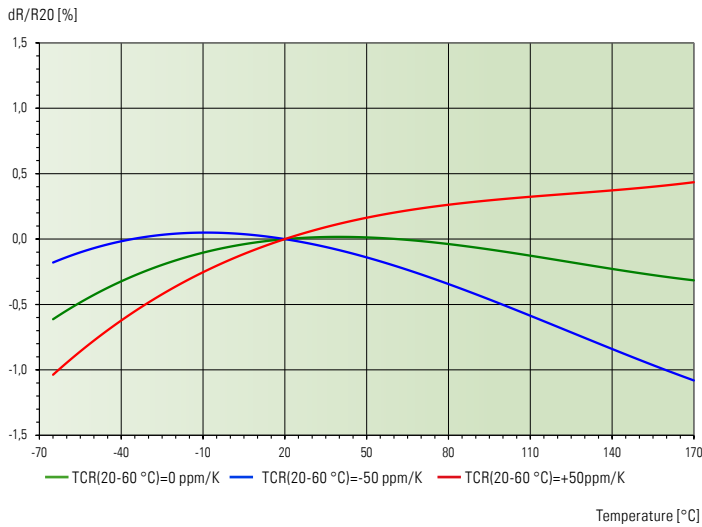

**Temperature dependence of the electrical resistance of NOVENTIN® resistors**

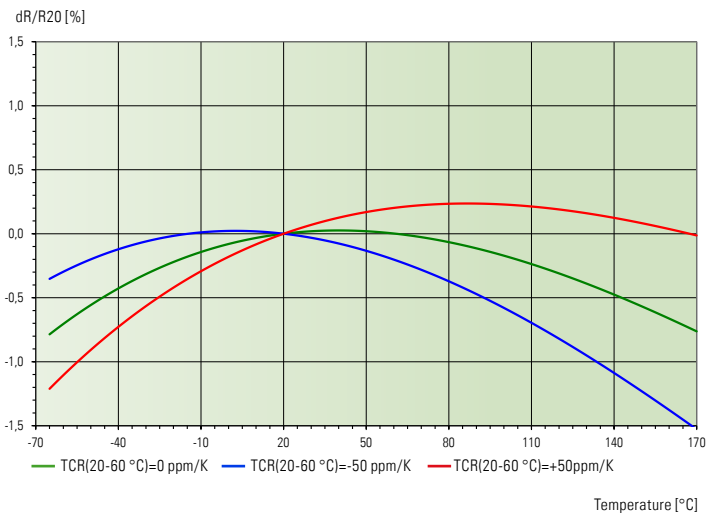

**Power derating curve**

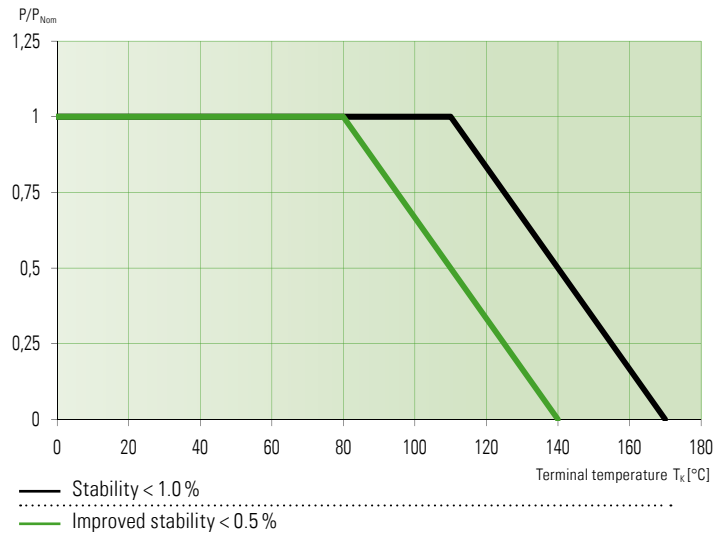



**FMK // Size 1206**

**Maximum pulse energy respectively pulse power for permanent operation**

**FMK-M-R002; FMK-V-R004; FMK-V-R006**  
 Maximum pulse energy / power continuous operation ( $T_K = 110\text{ °C}$ )

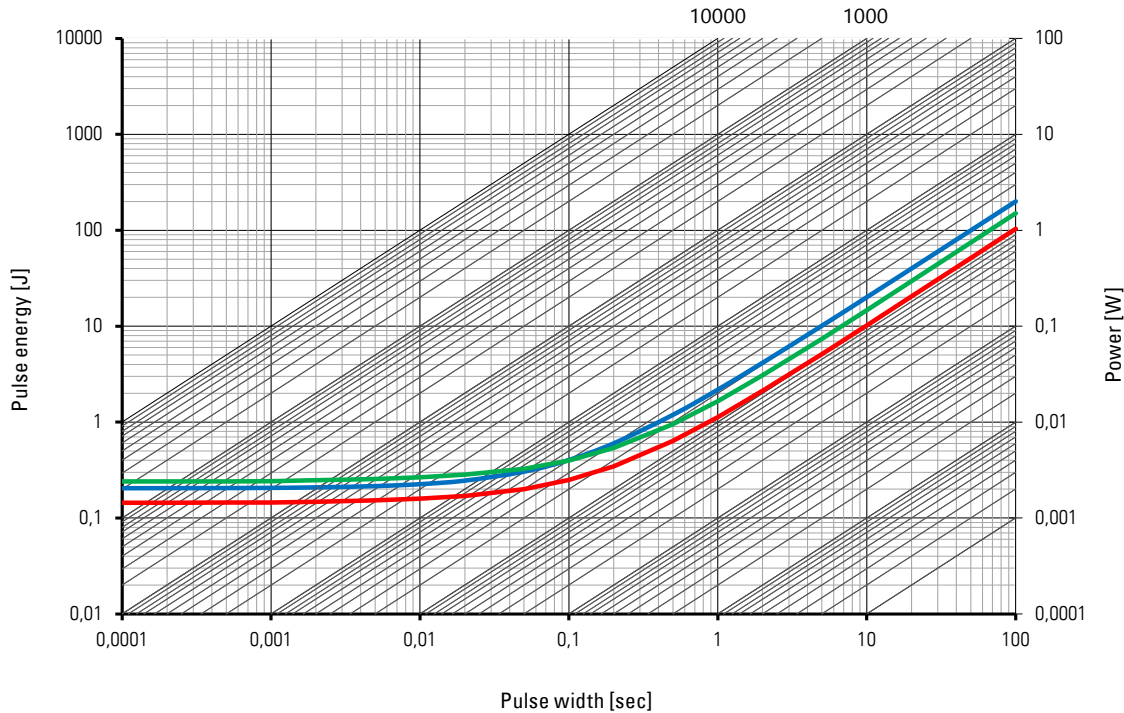

**Specification**

Parameters	Test conditions	Specified values
Temperature Cycling	1000 cycles (-55 °C to +150 °C)	±0.5%
Low Temperature Storage	-65 °C for 250 h	±0.1%
Moisture Resistance	MIL-STD-202 method 106	±0.5%
Mechanical Shock	100 g, 6 ms half sine	±0.2%
Vibration, High Frequency	10 g, 10-2000 Hz, 24 h each axis	±0.2%
Operational Life	2000 h, $T_K = 110\text{ °C}$ at rated power	±1.0%
High Temperature Exposure	2000 h at 140 °C	±0.5%
	2000 h at 170 °C	±1.0%
Bias Humidity	+85 °C, 85 r.F., 1000 h, powered	±0.5%

**Disclaimer** // All products, product specifications and data are subject to change without notice.

The product specifications do not expand or otherwise modify Isabellenhütte's terms and conditions of sale, including but not limited to, the warranty expressed therein. Isabellenhütte makes no warranty, representation or guarantee other than as set forth in its terms and conditions of sale.

Information provided in datasheets and/or specifications may vary from actual results in different applications. Any statements made by Isabellenhütte regarding the suitability of products for certain types of applications are based on its knowledge of typical requirements that are often placed on its products. It is the customer's responsibility to validate that a particular product with the properties described in the product specification is suitable for use in the application intended.

No license, express or implied, or otherwise, to any intellectual property rights is granted by this document. Any and all liability arising out of the application or use of any product shall be as set forth in Isabellenhütte's terms and conditions of sale.

