

Specifications 技术参数

Square body fuse links

Ratings & Features Applications 电气参数/功能应用领域:



- ◇ Volts 电压: 1500Vdc;
- ◇ Amps 电流: 100-630A;
- ◇ Interrupting Capacity 分断:
 - Max 1500Vdc 50kA;(or less)
 - Min BC ≥5In;
- ◇ Time Constant 时间常数: ≤5ms; ;
- ◇ Class Type 产品类别: aR;
- ◇ Design For Dc Applications 直流应用设计;
- ◇ Excellent Dc Performance 卓越的直流分断能力;
- ◇ Superior cycling capability 可循环利用率高
- ◇ Low Watt Losses 低功率损耗;
- ◇ Electrical Energy Storage 电能/储能;
- ◇ Disconnect or Maintenance Safety Disconnect 隔离开关、维护开关
- ◇ Battery Pack Protection 动力电池包保护;
- ◇ Backup Protection For Dc Relay 直流继电器保护;



Standards / Approvals 认证/标准:

- ◇ Refer To UL 248.1/UL 248.13
- ◇ IEC 60269.1/IEC 60269.4
 - 性能参考UL 248.13及IEC60269.4;
- ◇ Reach Declaration Available Upon Request;
 - 可根据要求提供REACH声明;
- ◇ UL, TUV;
- ◇ RoHS Compliant.
 - 符合RoHS。

Features & benefits 产品特性:

Higher voltage rating provides overall system efficiency using smaller, more economical conductors while meeting the needs of higher voltage. Up to ten times faster opening under high fault current conditions helps assure reliable protection of circuits and components. Greater ampacity within sizing guidelines, Excellent power of resisting voltaic impingement and environment temperature tolerance, Excellent resistance to mechanical vibration and impact resistance.

满足高电压、小尺寸、更经济的导体使用，提升整体系统效率，同时满足更高电压的需求。在大的故障电流条件下，断开速度快，确保电路和部件的可靠保护。实现尺寸范围内更大的载流量。良好的抗电流冲击能力以及冷、热环境温度耐受能力，具有优越的抗机械振动与冲击能力。

Product Model 产品型号说明:

	HC	HV	I	1500	:	400	A	:	59ES
HC:	Company Code								
HV:	High Speed								
T:	Ceramics								
Rated Voltage:	1500: 1500V								
Rated Current:	400: 400A								
x: Connect:	A (Flush-end contact)								
Type Series Code:	2#: 59ES								

Dimensions (mm)尺寸

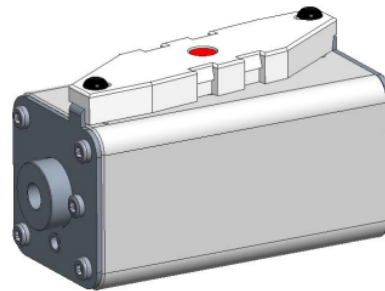
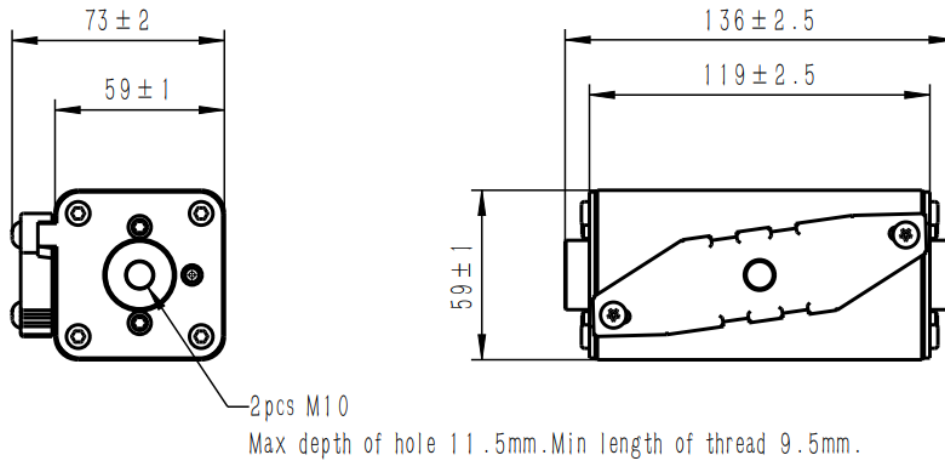

Fuse Ratings 额定参数

Connect	Part No.	Fuse Amps	Average @50KA/1500Vdc		Power Loss (W)		Approvals	
			A ² s Melting	A ² t Clearing	80%	100%	UL	TUV
Flush-end contact	HCHVT1500-100A-59ES	100A	2370	8857	41	53	•	•
	HCHVT1500-125A-59ES	125A	4890	13219	47	60	•	•
	HCHVT1500-160A-59ES	160A	7192	19440	50	64	•	•
	HCHVT1500-200A-59ES	200A	11066	29907	68	86	•	•
	HCHVT1500-250A-59ES	250A	17940	48480	86	107	•	•
	HCHVT1500-315A-59ES	315A	30568	82610	102	127	•	•
	HCHVT1500-350A-59ES	350A	40655	109878	109	136	•	•
	HCHVT1500-400A-59ES	400A	58496	158090	121	151	•	•
	HCHVT1500-450A-59ES	450A	78890	213215	128	161	○ Pending	○ Pending
	HCHVT1500-500A-59ES	500A	101503	274330	139	174	○ Pending	○ Pending
	HCHVT1500-550A-59ES	550A	125982	340490	155	194	○ Pending	○ Pending
HCHVT1500-630A-59ES	630A	185020	500100	162	203	○ Pending	○ Pending	

◇ DC Cold Resistance are measured at <10% of rated current in ambient temperature of 25°C;

◇ •: UL: E533379 (100-400A) ; TUV: J50590371 (100-400A)

◇ ○: Application process to be determined

◇ *Time-Current Curve时间电流曲线图

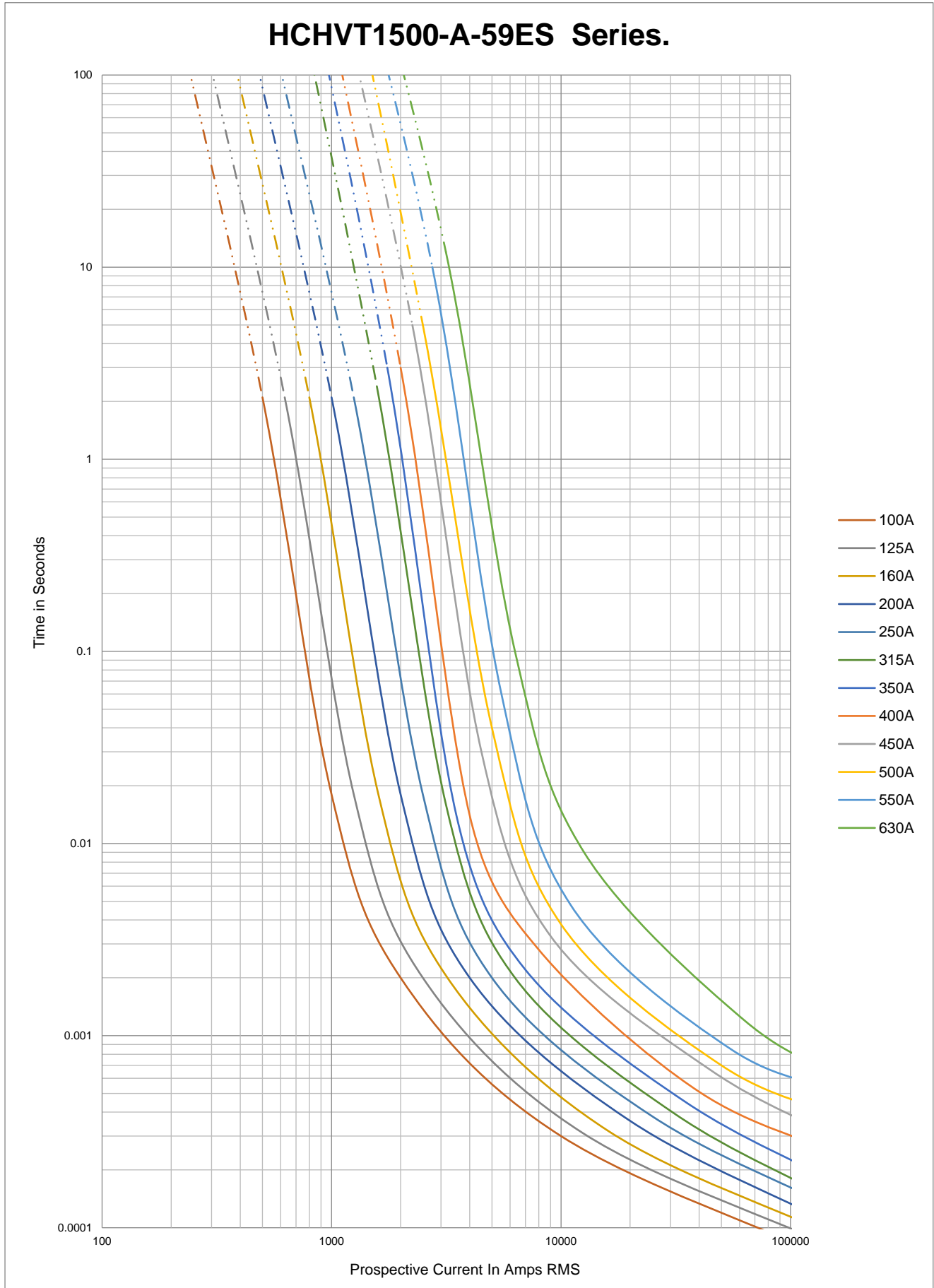

1: The accuracy of the characteristic curve is $\pm 15\%$ of the current direction error;

2: Minimum breaking current: 5.0 In

Operating conditions 使用条件**储存****Storage**

- ◇ Product storage Temperature: -40°C~120°C;
产品存储温度: -40°C~120°C, 在40°C时相对湿度不大于70%;
- ◇ Product storage Humidity: T=40°C RH≤70%, T≤30°C RH≤80%, T≤20°C RH≤90%;
在30°C以下, 产品相对湿度不大于80, 在20°C以下, 相对湿度不大于90%;
- ◇ Package storage Temperature: -40°C~80°C(-40°F~176°F);
包装存储温度: -40°C~80°C;

正常使用条件及参数修正**Normal usage conditions and parameter corrections**

- ◇ Fuses can perform regularly under the flowing conditions without corrections;
熔断器在下述的正常使用条件下工作, 不需要额外的修正;
- ◇ Regular current flow should $\leq 75\%$ of recommended rated current;
推荐长期通流的电流值不大于额定电流的75%;

周围空气温度 Kt**Ambient air temperature Kt**

- ◇ Operating temperature: -5°C~40°C;
正常使用条件: -5°C~40°C;
- ◇ Allowable operating temperature:-40°C~ 85°C;
允许使用条件: -40°C~ 85°C;
- ◇ Temperature correction factors: when below -5°C, low overload (L.O.) pre-arcing time will slightly extend, rated current will slightly increase;
周围空气温度变化的参数修正: 在低于-5°C下工作, 熔断器的低倍过载电流的弧前时间略有延长, 额定电流略有增大, 一般不参考增加熔断器额定电流;
- ◇ If operating above 40°C (104°F) , rated current need extra corrections, factors: -Kt.
熔断器在40°C以上工作, 额定电流需要额外的修正, 修正系数为-Kt。
- ◇ *Note: Kt value has already considered the safety current allowance under regular operating scenarios.
- ◇ *注1: Kt的取值已考虑熔断器在正常工作条件下的额定电流安全余量的影响。

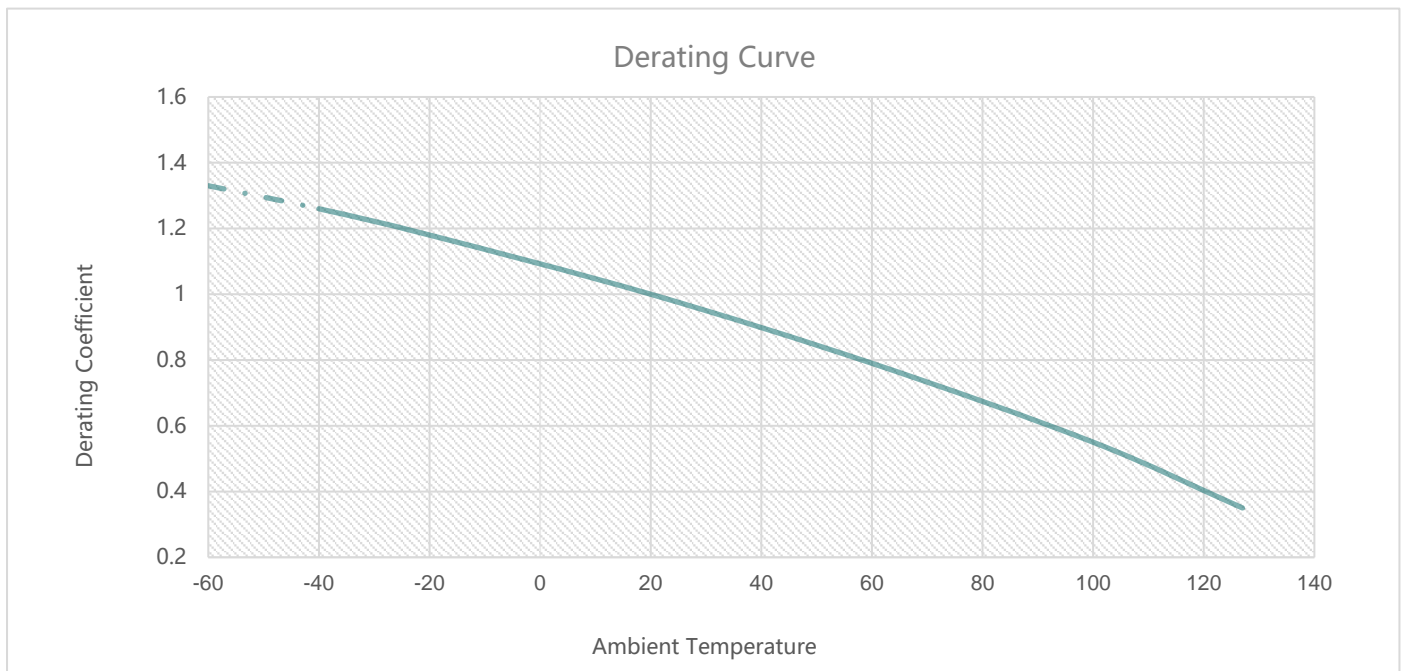

海拔 Ka**Altitude Ka**

正常使用条件 **Normal usage conditions**

海拔不超过2000m。 The altitude does not exceed 2000m.

允许使用条件 **Allowed use conditions**

2000-4500m。

◇ 海拔高度变化的参数修正：较高海拔主要带来绝缘劣化，散热条件劣化，气压力变化。

Parameter correction for altitude changes: Higher altitude brings insulation degradation, deterioration of heat dissipation conditions, and changes in air pressure.

◇ 海拔每升高100米，熔断器的温升上升0.1-0.5k。

For every 100 meters of altitude increase, the temperature rise of the fuse increases by 0.1-0.5k.

◇ 海拔每升高100米，环境温度平均降低0.5k左右。

For every 100 meters of altitude increase, the ambient temperature decreases by about 0.5k on average.

◇ 一般情况下，在开放环境使用的熔断器，可忽略海拔高度对额定电流的影响，仍然按照标准条件选用。

Generally, for fuses used in open environments, the effect of altitude on the rated current can be ignored, and they are still selected according to standard conditions.

◇ 在封闭环境使用的熔断器，如果其箱体的环境空气温度或箱体内部的温度并不随海拔升高而明显下降，仍然可以达到40°C以上，则需要对额定电流降容。海拔每升高1000米，额定电流降容2%-5%。

For fuses used in closed environments, if the ambient air temperature of the box or the temperature inside the box does not drop significantly as the altitude increases, and can still reach above 40°C, the rated current needs to be derated. For every 1000 meters of altitude increase, the rated current should derate by 2%-5%.

注：同一尺寸系列中，最大额定电流采用较高的降容比例，较小的额定电流采用较低的降容比例。

Note: In the same size series, the maximum rated current adopts a higher derating ratio, and the lower rated current adopts a lower derating ratio.

海拔高度空气绝缘强度（击穿强度）的影响。

Effect of altitude air insulation strength (breakdown strength).

◇ 海拔升高，则空气绝缘强度下降。2000-4500米内，海拔每升高1000米，绝缘强度降低12-15%。

As the altitude increases, the air insulation strength decreases. Within 2000-4500 meters, the insulation strength decreases by 12-15% for every 1000 meters of altitude increase.

◇ 参见 GB/T16935.1,应对绝缘间隙进行相应修正。

Refer to GB/T16935.1, the insulation gap should be corrected accordingly.

◇ 熔断器端子间的绝缘距离一般远大于GB/T16935.1,表A1, A2标准要求的绝缘间隙，除个别体积较小的熔断体外，无需校核绝缘间隙。

The insulation distance between fuse terminals is generally much greater than the insulation gap required by standards of GB/T16935.1, Table A1, and A2. Except for a few small fuse links, there is no need to check the insulation gap.

熔断器带与其它带电结构间,以及对地的绝缘间隙，需要由用户考虑海拔高度的影响。

The insulation gap between the fuse and other live structures, as well as the ground, needs to be considered by the user due to the influence of altitude.

◇ When fuses are used at high altitudes, the current rating should be corrected, the correction factor is shown in the Following table: $K_a = 1 - (H - 2000) / 100^* (0.5 / 100)$

◇ Under these conditions, moderate condensation may occasionally occur due to variation in temperature. For operation condition other than above, please contact manufacture

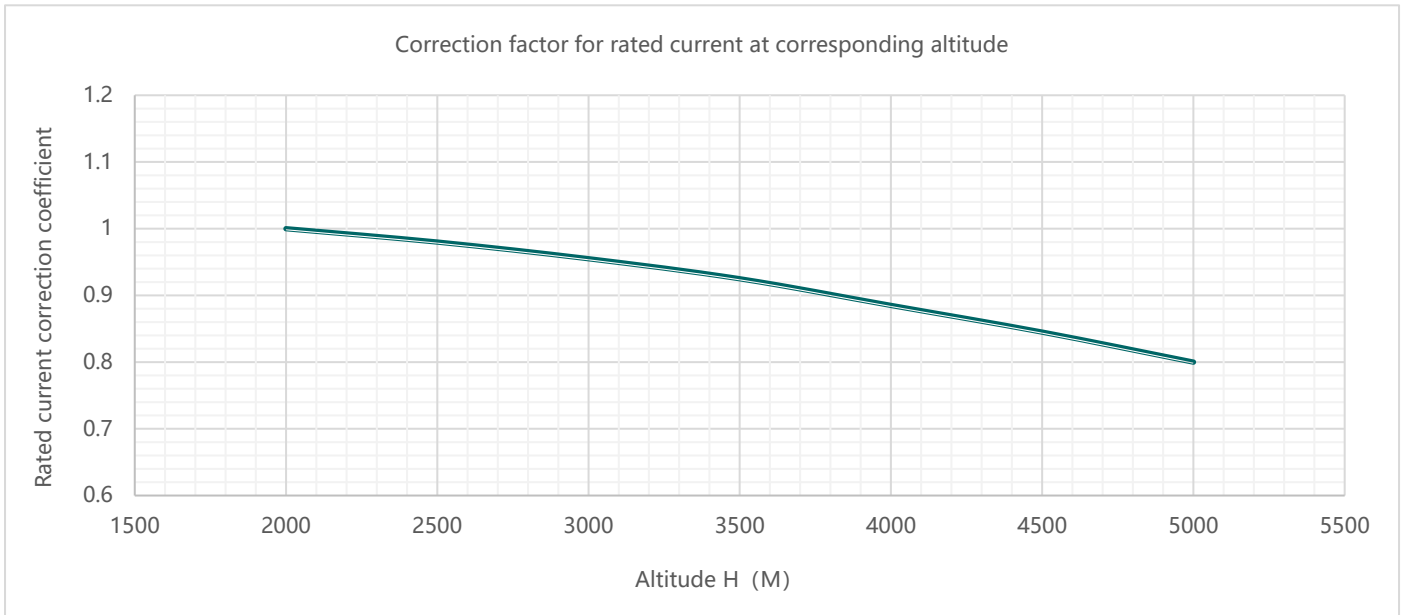

◇ 连接器件热传导条件 Ke

◇ Thermal conduction conditions of connecting devices Ke

Ke: 标准连接铜导线截面 (电流为长期持续有效值的标定)

Ke: cross-sectional area of standard connecting copper wire (The current is a long-term continuous effective value)

电流 A	截面积 mm ²	电流 A	截面积 mm ²	电流 A	截面积 mm ²
2、4、6	1	80	25	400、425	240
8、10、12	1.5	100	35	450、500	300
16、20	2.5	125	50	630	370
25	4	160	70	800	480
32	6	200、225	95	1000	600
40、50	10	250、280	120	1250	800
63	16	300、315、350	185	-	-

* > 1250A以上的电流指标商定

The index of current above 1250A

*1 电流1250A~2000A, 过电流密度取1.0~1.4A/mm²

When the current is 1250A~2000A, and the overcurrent density is 1.0~1.4A/mm²

*2 电流2000A~3000A, 过电流密度取0.9~1.0A/mm²

When the current is 2000A~3000A, the overcurrent density is 0.9~1.0A/mm²

◇ Connecting conductor cross-section/standard cross-section

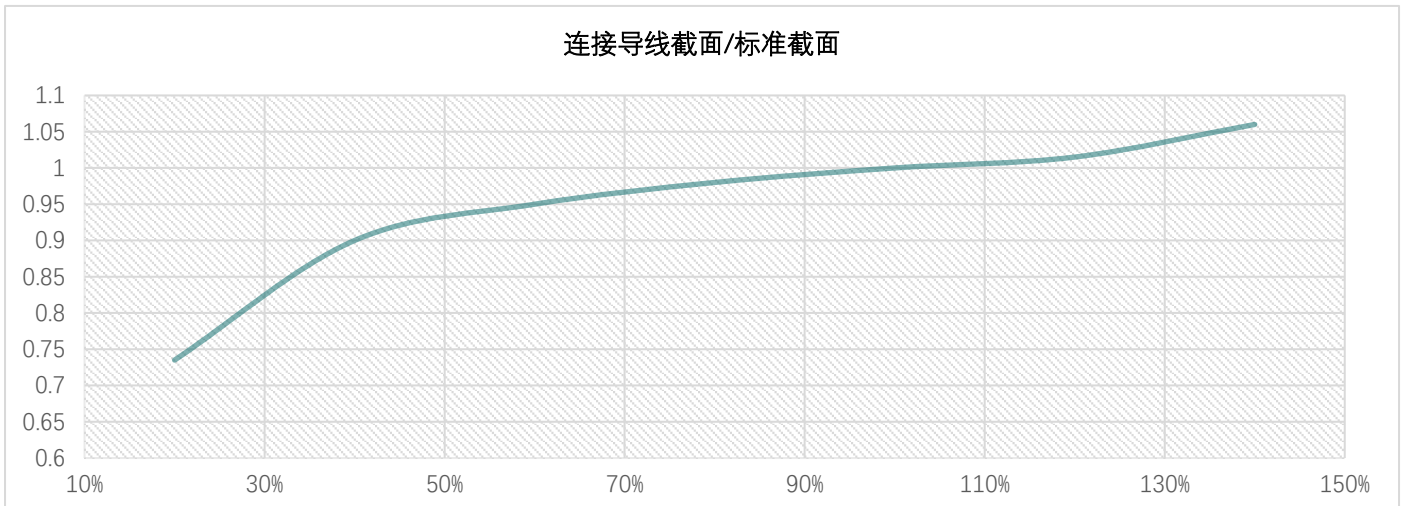

强制风冷Kv**Forced air cooling Kv**

✧ 熔断器单独安装在无通风的自然空气中，除连接导线外，1m范围内无其他发热部件或散热部件。

The fuse is installed separately in the natural air without ventilation. Except for the connecting conductor, there are no other heating parts or heat-dissipating parts within 1m.

✧ 熔断器连接端子应保证电接触稳定可靠。接触电阻不应明显影响熔断器工作。

The fuse connection terminal should ensure stable and reliable electrical contact. Contact resistance should not significantly affect fuse operation.

✧ 熔断器可垂直、水平或倾斜安装。如果是依靠弹簧压力保证电连接熔断器，安装时，宜选择合适位置，避免重力和振动对电连接的不良影响。

Fuses can be installed vertically, horizontally, or at an angle. If it relies on spring pressure to ensure the electrical connection of the fuse, a suitable location should be chosen during installation to avoid the adverse effects of gravity and vibration on the electrical connection.

强制风冷 Forced air cooling

采用强制风冷可以增加熔断器的散热，可以增加熔断器的额定电流。风速和额定电流的修正系数—Kv。

The use of forced air cooling can increase the heat dissipation of the fuse and increase the rated current of the fuse. Correction factor for wind speed and rated current—Kv.

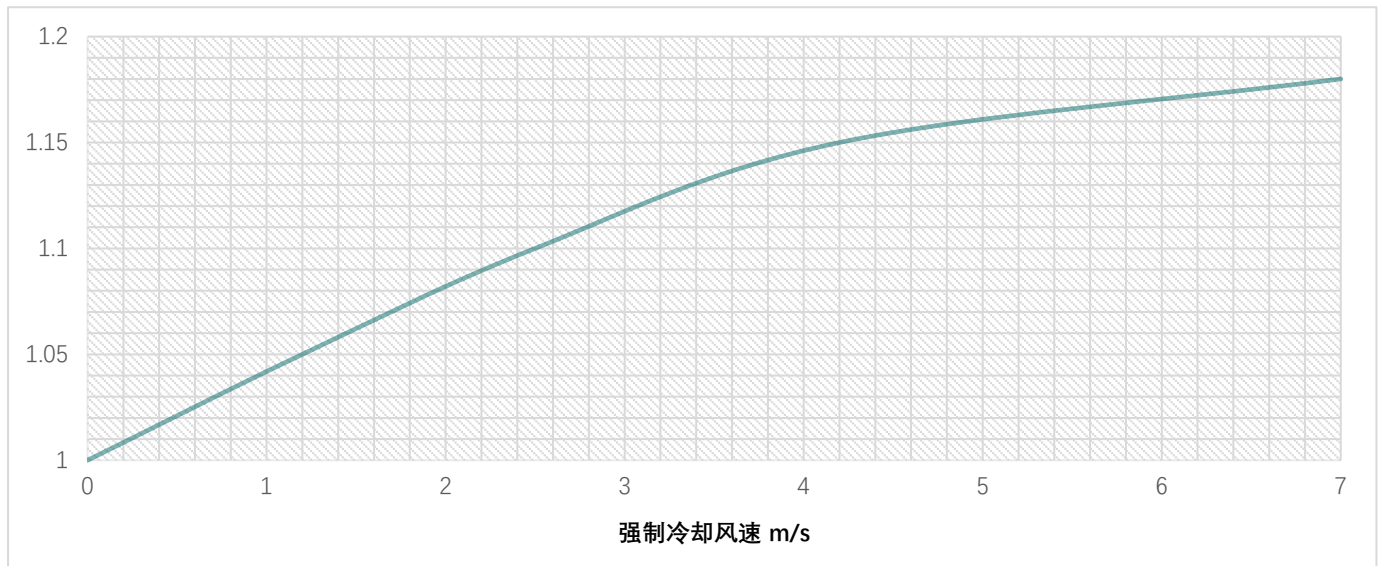

Forced cooling wind speed m/s

大气条件**Atmospheric conditions**

✧ 正常工作条件

Normal working conditions

空气是干净的，它的相对湿度在最高温度为40°C时不超过50%。

The air is clean and its relative humidity does not exceed 50% at a maximum temperature of 40°C.

✧ 在较低温度下可以有较高的相对湿度，例如，在20°C下，相对湿度可以达90%。

There can be higher relative humidity at lower temperatures, for example, at 20°C, the relative humidity can reach 90%.

在这些条件下，由于温度的变化，中等的凝露可能偶然发生。

There can be higher relative humidity at lower temperatures, for example, at 20°C, the relative humidity can reach 90%.

✧ 允许工作条件 Permissible working conditions

无明显凝露情况下，相对湿度可达95% Without obvious condensation, the relative humidity can reach 95%

震动

Shock vibration

- ◇ High frequency vibration resistance: $\geq 20g$;
本系列熔断器有良好的抗振动和冲击的耐受能力, 可承受20g以上的加速度;
- ◇ Intense vibration and shocking conditions need more tests.
振动较为强烈的应用环境, 可商议进行对应测试, 一般要经过较长的周期。
- ◇ Replacing fuses if damaging facilities;
对有机机械损伤的熔断器必须进行更换;
- ◇ DO NOT change fuses while loading unless MUST.
除非使用要求允许, 如熔断器式负荷开关, 否则请勿带负载更换熔断器。

安全使用和维护保养

Safe use and maintenance

- ◇ 熔断器安装时, 相邻两个熔断器带电零件的最小间隙满足绝缘要求, 必要的话在熔断器之间装绝缘隔板, 以防止带电更换熔断器时引起相间短路。

When installing fuses, the minimum gap between the live parts of two adjacent fuses meets the insulation requirements. If necessary, install an insulating partition between the fuses to prevent phase short circuits when replacing the fuses while the fuses are live.

- ◇ 结合电气设备定期检修, 进行检查和维护保养, 清除尘埃、接触导电部位的氧化层等。

Combined with regular inspection of electrical equipment, carry out inspection and maintenance, remove dust, oxide layers on contact conductive parts, etc.

- ◇ 对有机机械损伤的熔断器必须进行更换。

Mechanically damaged fuses must be replaced.

- ◇ 除非使用要求允许, 如熔断器式负荷开关, 否则请勿带负载更换熔断器。

Unless the application requirements allow it, such as a fuse-type load switch, do not replace the fuse with the load.

- ◇ 产品寿命期间无任何废气、粉尘、噪音等影响环境因素的产生。

During the life of the product, there will be no waste gas, dust, noise or other factors that affect the environment.

- ◇ 产品寿命终结后金属件可回收, 非金属件粉碎后可作为一般工业垃圾处置, 对环境不会造成二次污染。

The metal parts can be recycled after the end of the product's life, and the non-metal parts can be disposed of as general industrial waste after being crushed, without causing secondary pollution to the environment.